

AIR DRIVEN GAS BOOSTERS, LIQUID PUMPS, AIR AMPLIFIERS AND HIGH PRESSURE VALVES, FITTINGS & TUBING

ROB 22(-HL) Rebreather Oxygen Booster

The Maximator® ROB rebreather oxygen booster is specifically designed for use in the sport diving field. This compact compressed air or hand driven oxygen booster provides a rugged and reliable means of recharging rebreather size tanks.

ROB boosters:

- Are lightweight and portable
- Ideal for installing in a Pelican Case
- Finned Gas Barrel for efficient gas cooling
- Oxygen Cleaned
- Can be driven from either compressed air or from bottle supply

Wetted materials of construction:

- Seal package: Filled Teflon (PTFE) Viton
- Pump Body: 316L SS
- Piston: 440 SS
- Fittings: 316 SS

Approximate Dimensions:

- Height: 7 7/8"
- Depth: 4 5/8"
- Width: 4 5/8"
- Side inlet/outlet: Standard

Optional Accessory:

- ACP - Air control package consisting of a filter, regulator with gauge, shut-off valve and required fittings.
- Optional hand lever operation: HL



Technical Data:

Air drive pressure:	14.5 - 145 psi
Maximum Outlet Pressure at air drive of 145 psi:	4,060 psi
Pressure Ratio:	1:28
Displacement per cycle:	0.28 (In ³)

Connections:

Inlet:	1/4" NPT
Outlet:	1/4" NPT
Air Drive:	1/4" NPT
Maximum operating temperature:	140° F
Net Weight:	9 lbs.

Fill Times for 19 Cu Ft Tank (Minutes:Seconds)

Supply Pressure:	Fill Pressure:	
	2,500 psi	3,000 psi
750 psi	6:50	n/a
1,000 psi	2:23	4:41
1,500 psi	0:39	1:12
2,000 psi	0:18	0:45

Please see graph on reverse side for pressure and flow performance.

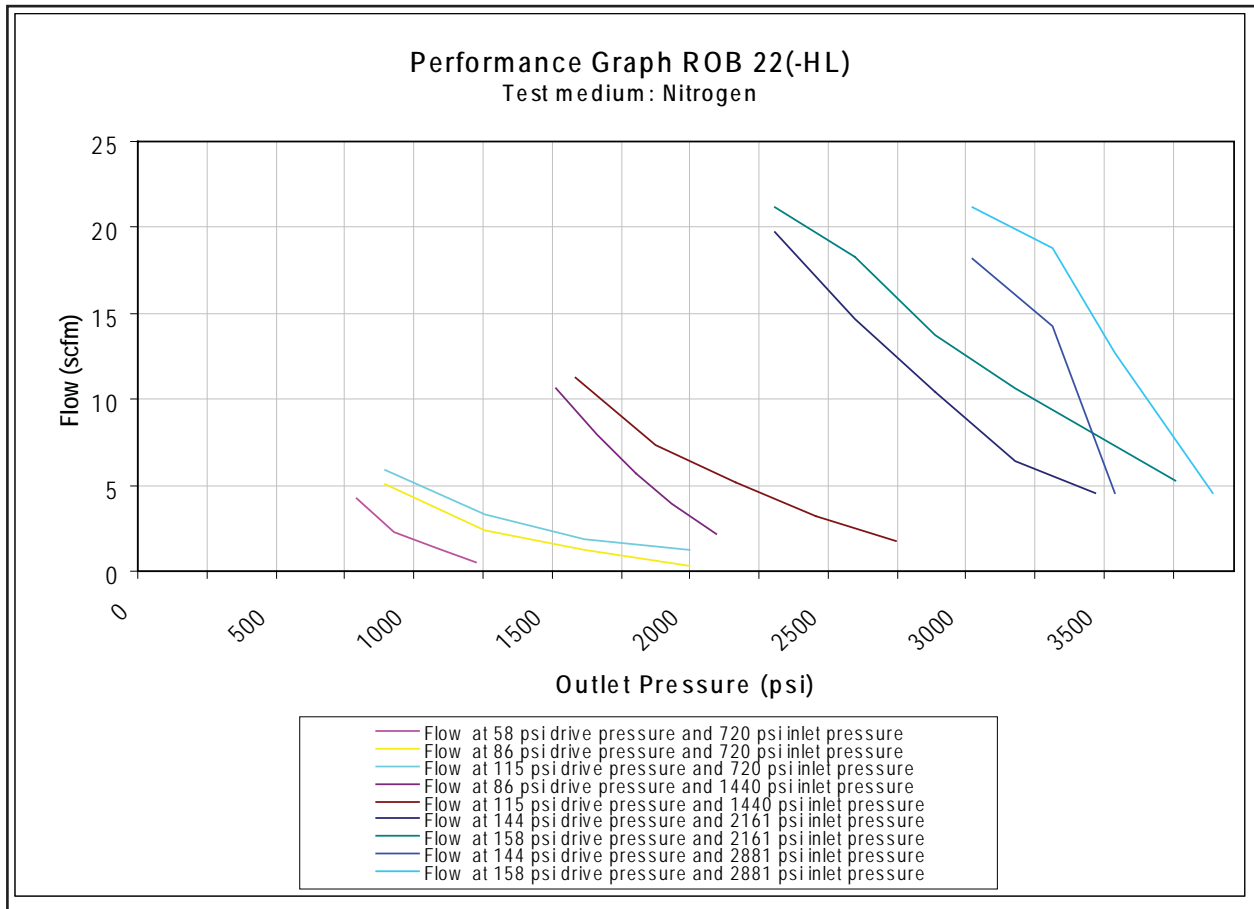
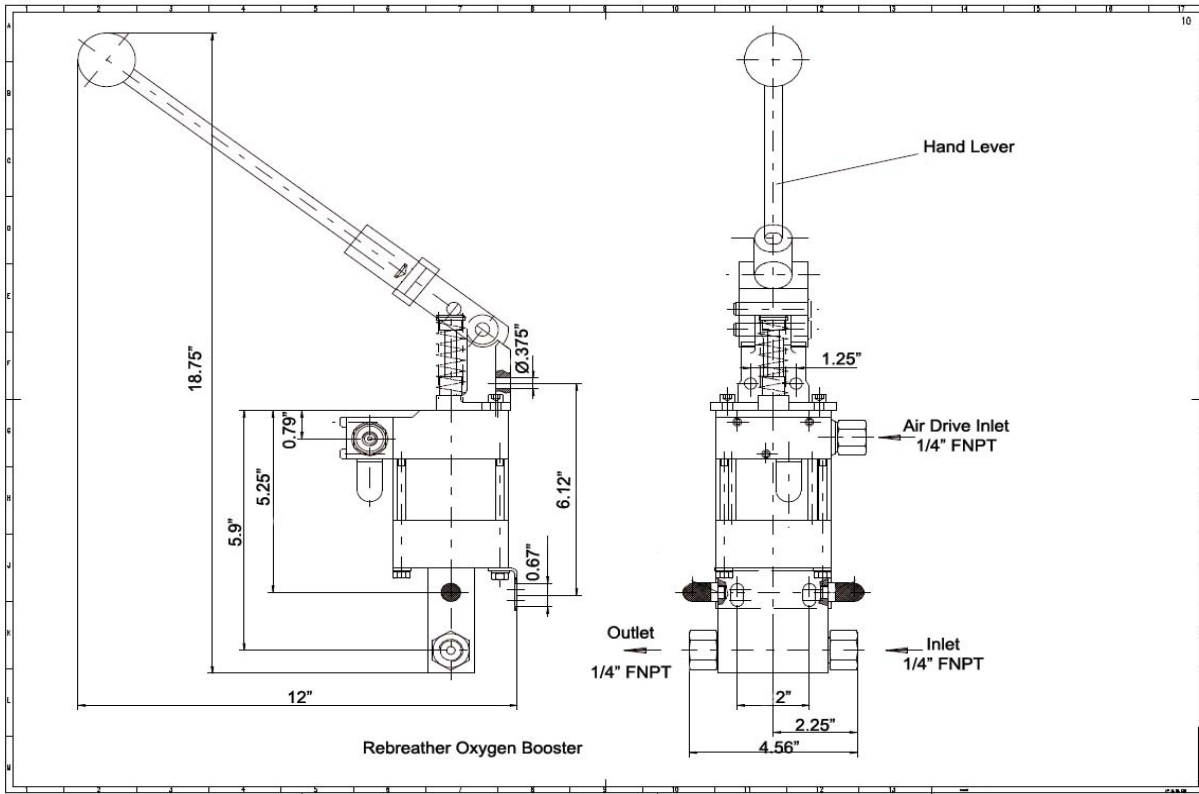

Please consult factory for more information. All technical and dimensional information subject to change. All General Terms and Conditions of sale, including limitations of our liability, apply to all products and services sold.